

## Bauer ProRain F30 F40 Hard Hose Data.



- PRORAIN F40 Galvanized with special PE-pipe
- Hot-dip galvanized 2-wheel undercarriage with fixed track 2,2m
- Revolving Galvanized pipe reel
- Hydraulic machine supports
- Undercarriage and turntable hot dip galvanized
- 4 speed gearbox with mounted turbine to Gearbox.
- Irrigation computer ECOSTAR 6000 with back-up battery
- Unit connection on both sides
- Pressure hose HK 108/7m with 2 rubber sealing rings HK 108
- Filter for main water flow 110
- Electric. overpressure shut-off shut-off valve
- Jack & swivel aid hydraulic with 4-fold valve block or Automatic cart lift
- solar panel
- Pressure sensor for ECOSTAR6000
- Larger 2-wheels 400/60-15,5 Pro-Rain
- Sprinkler SR 140 ULTRA w. nozzles 20,24 & 26 mm
- Winding handle
- Safety Guards with fully closed in Reel.

- Bauer has a unique pendulum style Big Gun action

## Protecting soil and crops

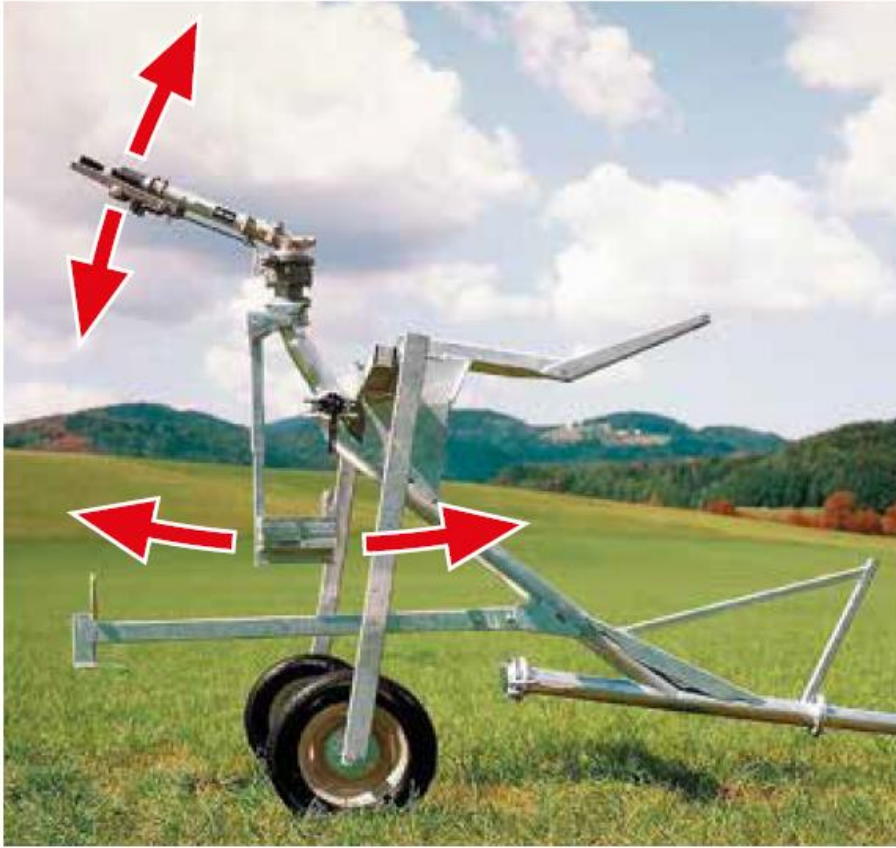

### **Crop-saving angle compensation**

Keeps the Rain-gun properly inclined on uneven ground, especially during the final rewind. Saves the crop from potential water jet damage.

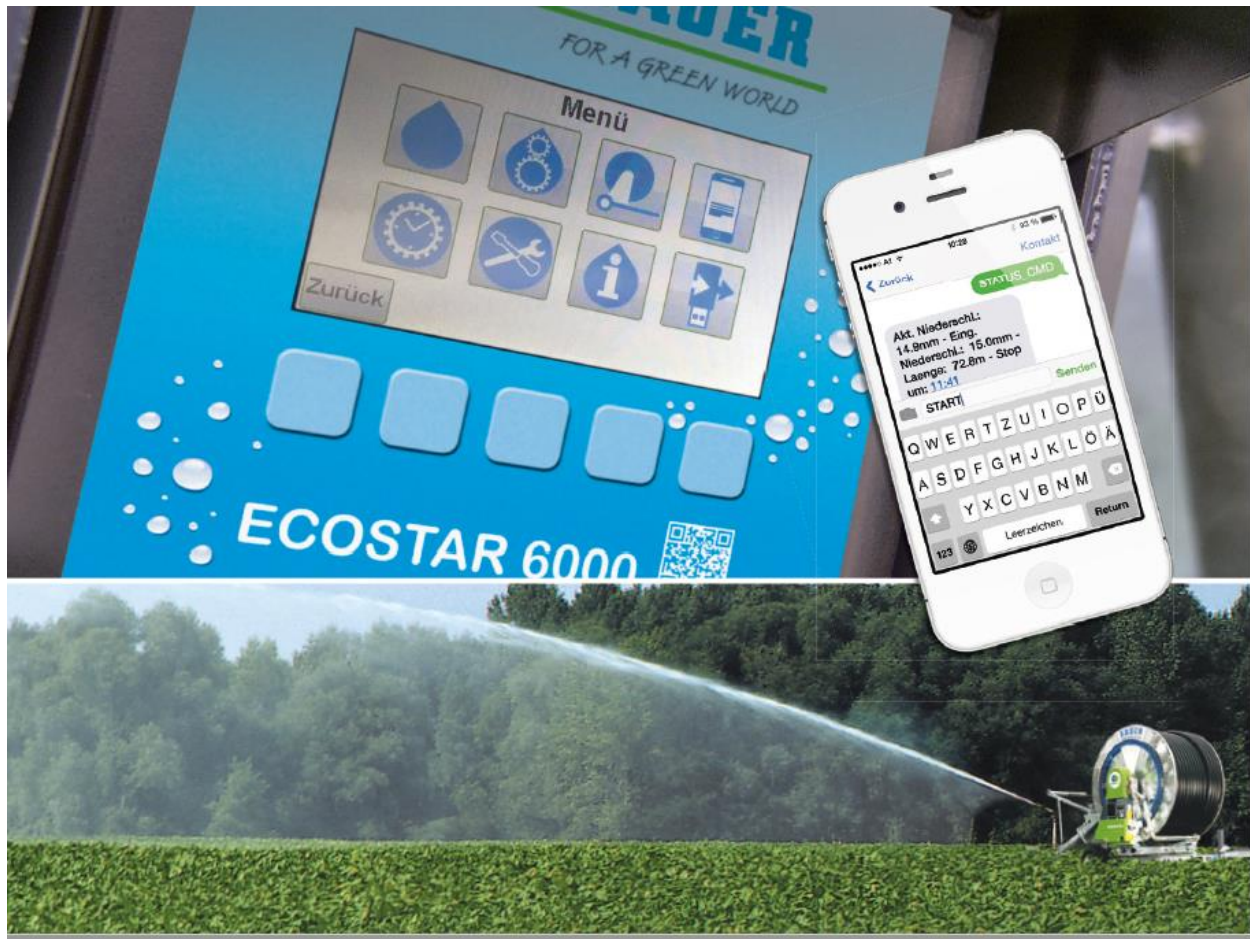



## EcoStar 6000

- Simple operation by the touch of a button or directly on the touch screen
- State of the art touch display with LCD backlight for optimum visibility
- Exact irrigation rates through permanent comparison between set and Actual retraction speed
- Easy programming of pre- and post-irrigation by direct selection
- SMS control and monitoring.

### New additions to EcoStar 6000

- 🌱 Gear shift button on the info screen:  
 Can be used to reduce turbine speed to make gear shifting during irrigation easier.
- 🌱 The shut-off valve can be opened or closed using the buttons on the info screen.  
 (To blow out the pipe, for example)

 Reduced energy consumption and new functions and settings to save energy.

 File download and software update via SmartRain.

 Improved controlling at high speed.

 Battery level indicator on the homescreen.

 Pre-Irrigation can be reset and restarted while irrigation is active.

 Irrigation time can be displayed instead of stop time.

 New options for pressure monitoring:

**Start:** Irrigation is started, as soon as the desired pressure is reached.

**Monitor:** Irrigation is started, as soon as the desired pressure is reached, and stopped if the current pressure is below the desired value for the set monitoring time.

**Measure:** A pressure sensor can also be used to just measure the current pressure and display it on the info screen.

## Drive technology

- 4-speed gear box / turbine combination by COMER
- Easy to handle
- Precise control for exact precipitation rate



### Comer Choke Flow Turbine and 4 Speed Gearbox .

m <sup>3</sup> /h		Düse/nozzle
> 36	offen/open	offen/open
27 - 36	geschlossen/close	Ø 20
18 - 27	geschlossen/close	Ø 16 oder/or Ø 18
9 - 18	geschlossen/close	Ø 12 oder/or Ø 14

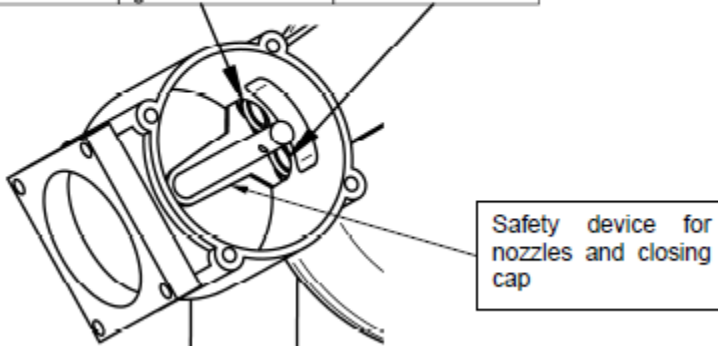



- **Shut off Valve for Automatic over pressure or flow shut down of water.**
- **Fully covered Electric Valve with Close and Open clearly marked.**

